







20 005 705

- with WAVES structure
- hole diameter 32 mm
- rosette 60 x 47 mm
- with cold marking



| | | |
|---|-------------------------------|---------------|
|  | Champagne (22kt Gold) | 20 005 705-47 |
|  | Chrome | 20 005 705-00 |
|  | Brushed Platinum | 20 005 705-06 |
|  | Dark Chrome | 20 005 705-19 |
|  | Brushed Champagne (22kt Gold) | 20 005 705-46 |
|  | Brushed Dark Platinum | 20 005 705-99 |

20 005 705

mm [inches]

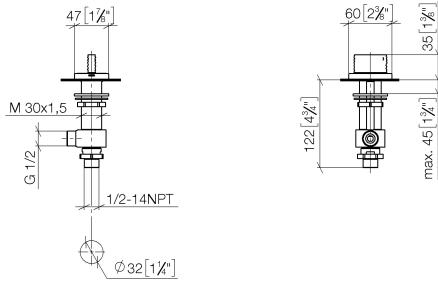

Flow rate chart



Certificates

IAPMO_N-4976.

LGA_28687.

IAPMO_6397.

WRAS_240202020.

20 005 705

Parts for other finishes can be found here: [Chrome](#)

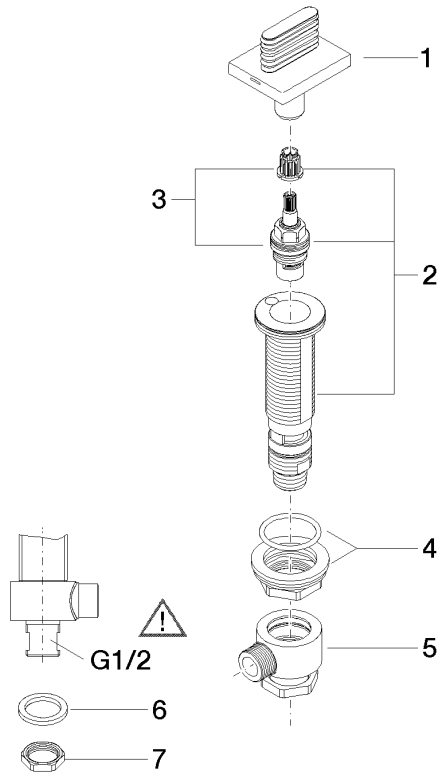

Spare parts list

| No. | Item Number | Name | Quantity used | Delivery time |
|-----|--------------------|--------------------|---------------|---------------|
| 1 | 90 20 70 055 06-47 | handle (cold) | 1 | 30 |
| 2 | 04 17 11 058 53 90 | side panel | 1 | 2 |
| 3 | 90 90 03 153 00 90 | top | 1 | 2 |
| 4 | 04 23 10 032 78 90 | fixing set | 1 | 2 |
| 5 | 04 17 11 023 10 90 | distributor | 1 | 2 |
| 6 | 90 23 30 040 00-47 | threaded connector | 1 | 30 |
| 7 | 09 30 11 059 90 | disc | 1 | 2 |
| 8 | 09 23 10 012 90 | nut | 1 | 2 |